

# W8CT

Dedicated longthrow high-mid / HF enclosure

## features

- ▶ Dedicated longthrow high-mid/HF enclosure
- ▶ Very high SPL capability
- ▶ Constant 55° horizontal dispersion
- ▶ Load certified MAN flying points

## applications

- ▶ Live sound – open-air venues

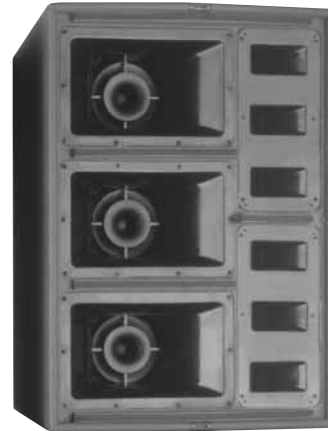

touring and professional

Throwing high frequencies over distance outdoors has always been a problem because of air absorption. The air attenuates high frequencies as they pass through it, so high frequency losses increase as the distance from the source increases. At 200 metres, air losses would require a boost of 30dB to restore the nearfield frequency response. Additionally, the large format compression drivers typically used exhibit a falling high frequency response and require 6dB of high frequency boost just to achieve a flat response at source. The total amount of EQ required would quite clearly place impossible demands on any single high frequency driver - particularly a large format compression driver with its naturally falling HF response. The HF acoustic power required is just not available from such a device.

To overcome this difficulty, the W8CT utilises a total of 6 x 1" (25mm) exit high frequency drivers, optimised for maximum efficiency in the band from 3.5kHz upwards. The 1" (25mm) exit drivers used are extremely efficient in this band and can produce enormous high frequency energy by virtue of their vertical line array configuration. Use of 1" (25mm) exit drivers is additionally important as it means that the HF array elements can be more closely spaced.

Further down the audio band, from 750Hz-3.5kHz, 3 x high-mid devices are again arranged vertically-in-line for maximum throw. Each high-mid device is a sophisticated design featuring a 6.5" (165mm) driver loaded by a toroidal phase plug and constant coverage horn moulding.

Century Point, Halifax Road, Cressex Business Park,  
High Wycombe, Buckinghamshire HP12 3SL, England.  
Telephone: +44 (0)1494 535312 Facsimile: +44 (0)1494 438669  
E-mail: [info@martin-audio.com](mailto:info@martin-audio.com)  
All information is Copyright © 2003 Martin Audio Ltd.



# W8CT

Dedicated longthrow high-mid / HF enclosure

polar plots

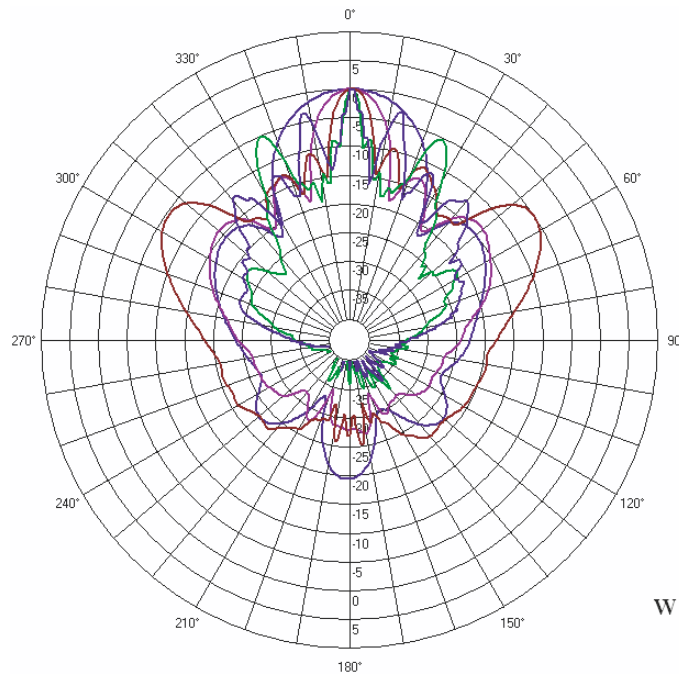

**W8CT Vertical Line**

- 800Hz & 1/3 oct. smoothing
- 1600Hz & 1/3 oct. smoothing
- 3200Hz & 1/3 oct. smoothing
- 6400Hz & 1/3 oct. smoothing
- 12800Hz & 1/3 oct. smoothing

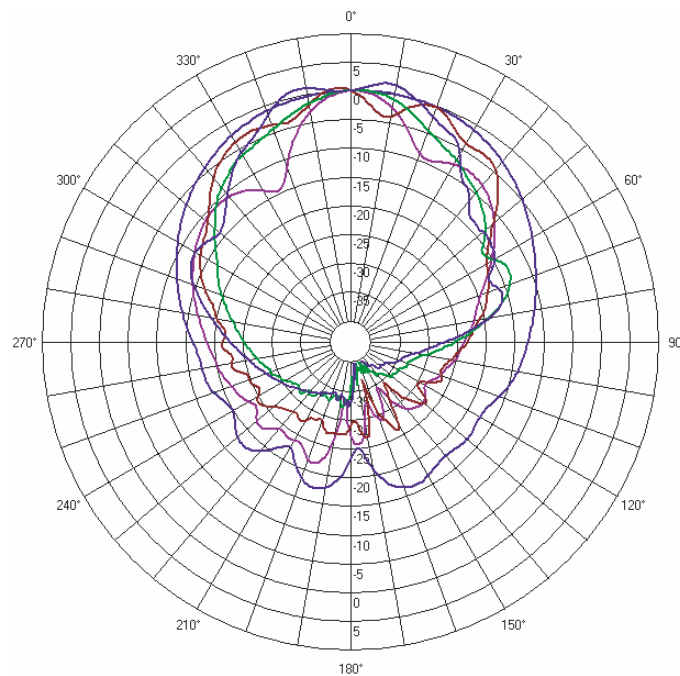

**W8CT Horizontal**

- 800Hz & 1/3 oct. smoothing
- 1600Hz & 1/3 oct. smoothing
- 3200Hz & 1/3 oct. smoothing
- 6400Hz & 1/3 oct. smoothing
- 12800Hz & 1/3 oct. smoothing

Century Point, Halifax Road, Cressex Business Park,  
High Wycombe, Buckinghamshire HP12 3SL, England.  
Telephone: +44 (0)1494 535312 Facsimile: +44 (0)1494 438669  
E-mail: [info@martin-audio.com](mailto:info@martin-audio.com)  
All information is Copyright © 2003 Martin Audio Ltd.



touring and professional

# W8CT

Dedicated longthrow high-mid / HF enclosure

frequency responses

touring and professional

W8CT Horizontal Magnitude in dB SPL/2.83V at 1 meter

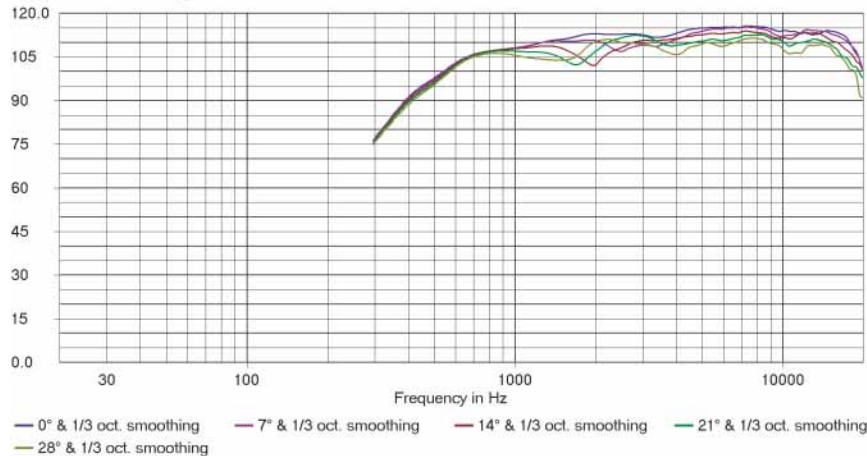

W8CT Horizontal Beamwidth

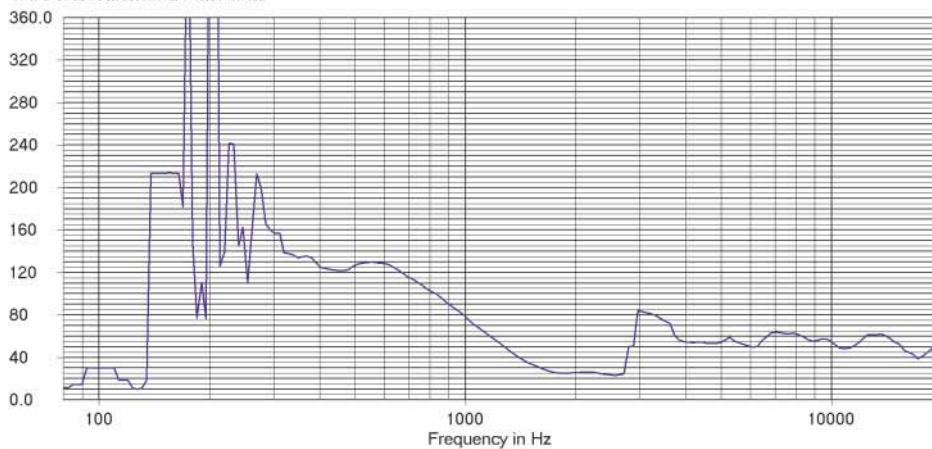

W8CT Vertical Beamwidth

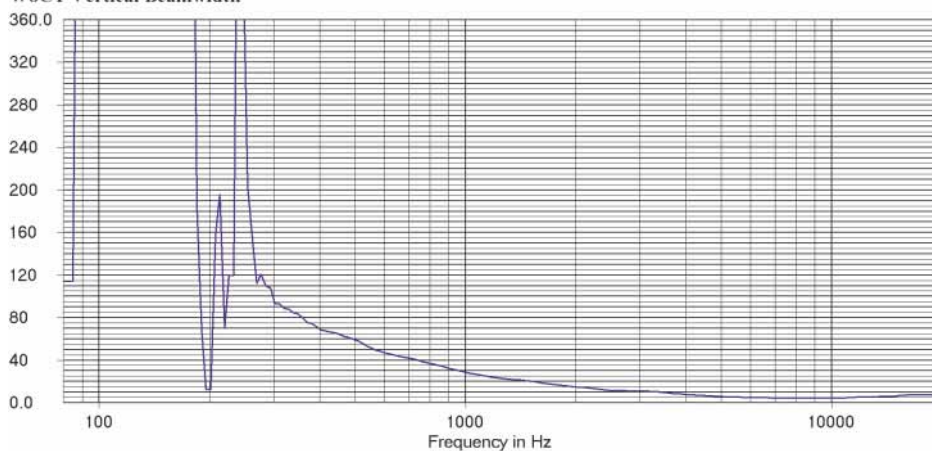

Century Point, Halifax Road, Cressex Business Park,  
High Wycombe, Buckinghamshire HP12 3SL, England.  
Telephone: +44 (0)1494 535312 Facsimile: +44 (0)1494 438669  
E-mail: [info@martin-audio.com](mailto:info@martin-audio.com)  
All information is Copyright © 2003 Martin Audio Ltd.



# W8CT

Dedicated longthrow high-mid / HF enclosure

overall dimensions

touring and professional

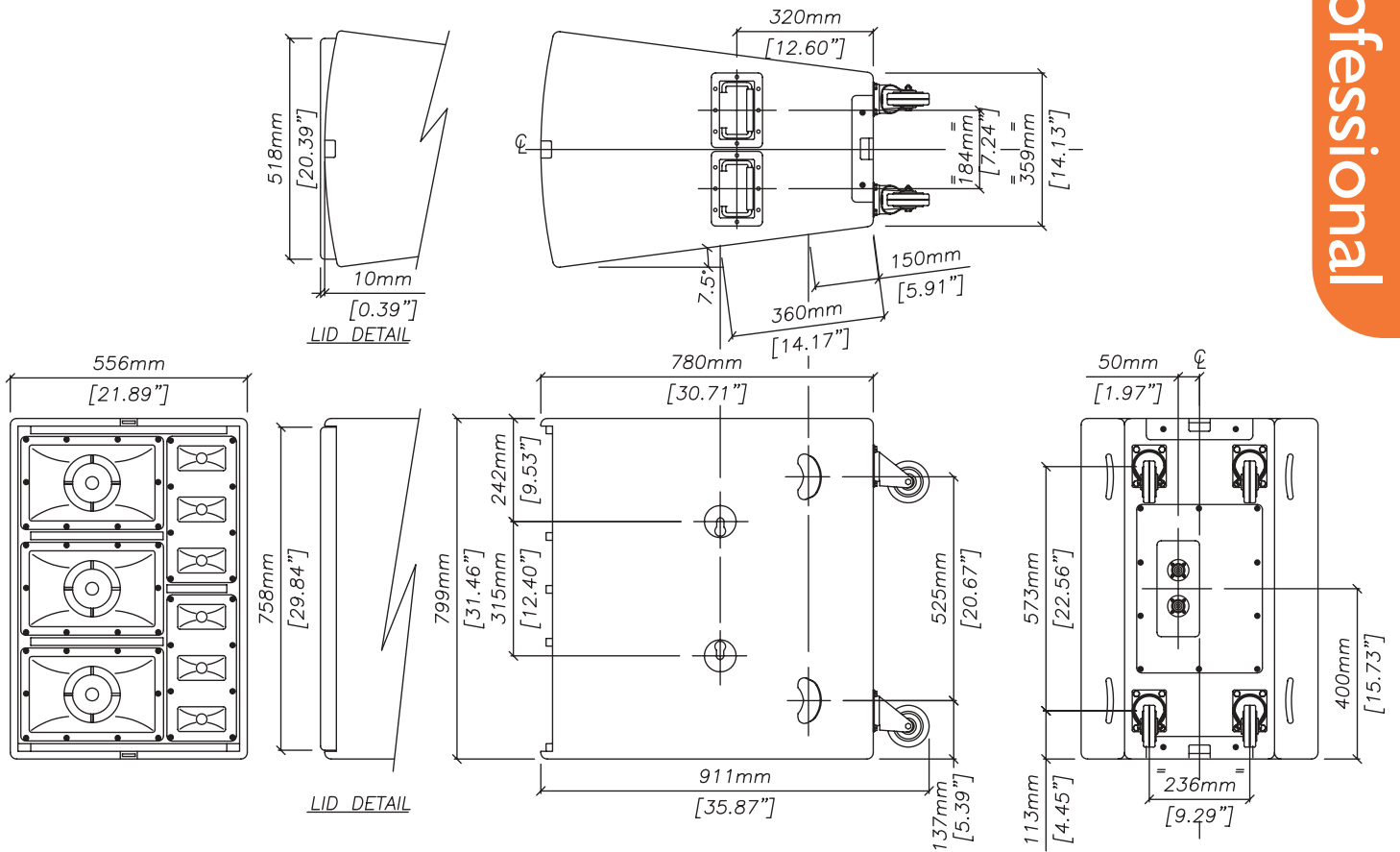

W8CT

Century Point, Halifax Road, Cressex Business Park,  
High Wycombe, Buckinghamshire HP12 3SL, England.  
Telephone: +44 (0)1494 535312 Facsimile: +44 (0)1494 438669  
E-mail: info@martin-audio.com  
All information is Copyright © 2003 Martin Audio Ltd.



# W8CT

Dedicated longthrow high-mid / HF enclosure

## technical specifications

TYPE	Dedicated longthrow high-mid/HF enclosure
FREQUENCY RESPONSE (1)	750Hz-18kHz $\pm$ 3dB
DRIVERS	3 x 6.5" (165mm) high-mid horn 6 x 1" (25mm) exit HF compression driver
RATED POWER (2)	High-mid: 450W AES, 1800W peak HF: 360W AES, 1440W peak
RECOMMENDED AMPLIFIER	400-550W into 4 ohms
SENSITIVITY (3)	High-mid: 113dB HF: 115dB
MAXIMUM SPL (4)	High-mid: 139dB continuous, 145dB peak HF: 141dB continuous, 147 peak
NOMINAL IMPEDANCE	High-mid: 6 ohms HF: 2 x 6 ohms
DISPERSION (-6dB)	55° horizontal, 7.5° vertical
CROSSOVER	750Hz, 3.5kHz
FINISH	Textured grey paint
PROTECTIVE GRILLE	Grey perforated steel
CONNECTORS	2 x Neutrik NL8
FITTINGS	4 x MAN Flying points
DIMENSIONS (inc. wheels)	(W) 556mm x (H) 799mm x (D) 780mm (911mm) (W) 21.9ins x (H) 31.5ins x (D) 30.7 ins (35.9ins)
WEIGHT	121kg (266lbs)

## accessories

W8FKIT	Flying chain assembly
HTKQF8	Quick release flying stud / D-ring
HTKHIS	Heavyweight install stud
HTKW8HingeKit	Complete hinge kit

### Notes

- (1) Measured on-axis in half space at 2 metres, then referred to 1 metre.
- (2) AES Standard ANSI S4.26-1984.
- (3) Measured in half space conditions at 2 metres with 1 watt input, using band limited pink noise, then referred to 1 metre.
- (4) Measured in half space conditions at 2 metres using band limited pink noise, then referred to 1 metre.

### Trade Descriptions Act

Due to Martin Audio's policy of continuing improvement, we reserve the right to alter these specifications without prior notice. Martin Audio is committed to refining state of the art sound reinforcement, combining in-depth product and field applications research with advanced manufacturing techniques. Every Martin Audio product is built to the highest manufacturing standards and rigorously tested to ensure that it meets the performance criteria specified in the design.

## architectural and engineering specifications

The loudspeaker system shall be of the dedicated longthrow high-mid / HF type. The high-mid section shall consist of three 6.5" (165mm) cone drivers each mounted on a constant directivity horn flare with integral toroidal waveguide. The high frequency section shall consist of six 1" (25mm) exit HF compression drivers each mounted on a constant directivity horn. The enclosure shall be of the heavily braced multi-laminate trapezoidal plywood type.

Performance of the loudspeaker system with its electronic controller shall meet or exceed the following criteria:

Frequency response measured 1 metre on axis shall be 750Hz-18kHz  $\pm$  3dB.

High frequency dispersion at -6dB points shall be 55°H x 7.5°V.

Power handling shall be 450W AES, 1800W peak High-mid, 360W AES, 1440W peak HF.

Rated impedance shall be 6 ohms High-mid, 2 x 6 ohms HF.

Maximum SPL measured at 1 metre on axis shall be 139dB continuous, 145dB peak High-mid, 141dB continuous, 147peak HF.

Dimensions (W) 556mm x (H) 799mm x (D) 911mm (21.9ins x 31.5ins x 35.9ins).

Weight 121kg (266lbs).

The loudspeaker system shall be the Martin Audio W8CT.